

Data sheet | Item number: 231-115/037-000

1-conductor female plug; Locking lever; 2.5 mm<sup>2</sup>; Pin spacing 5 mm; 15-pole

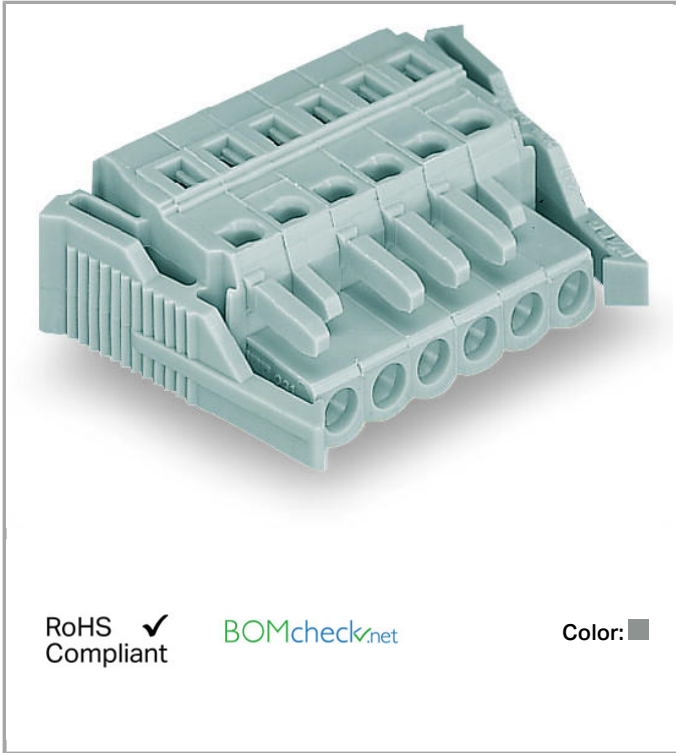

231-115/037-000



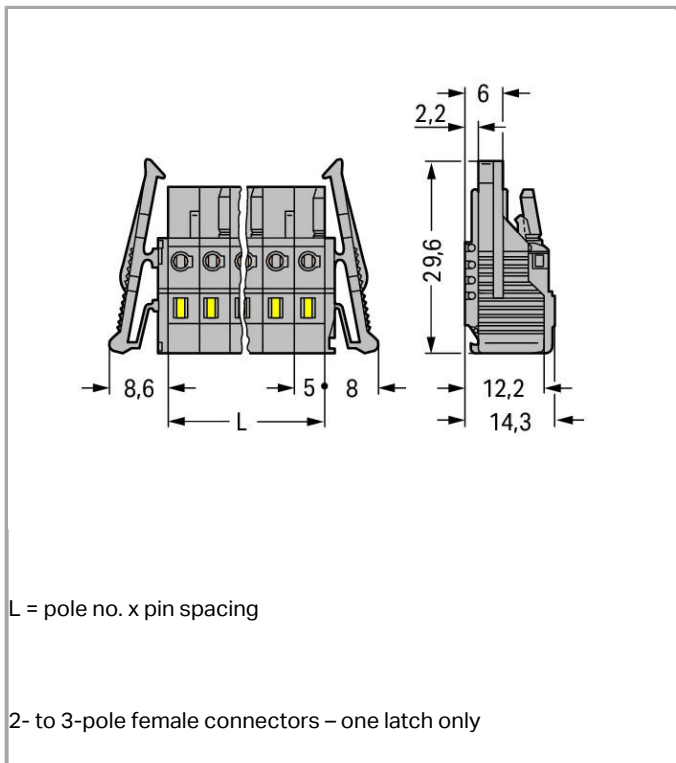

### Item description

- Universal connection for all conductor types
- Easy cable pre-assembly and on-unit wiring via vertical and horizontal CAGE CLAMP® actuation
- Integrated test ports
- With coding fingers

### Safety information 1:

The *MULTI CONNECTION SYSTEM (MCS)* is designed without breaking capacity for compliance with DIN EN 61984. When used as intended, MCS Connectors shall not be connected/disconnected when live or under load. The circuit design should ensure header pins, which can be touched, are not live when unmated.

### Data

#### Electrical data

#### Ratings per IEC/EN 60664-1

Rated voltage (III / 3)	320 V
Rated impulse voltage (III / 3)	4 kV
Rated voltage (III / 2)	320 V
Rated impulse voltage (III / 2)	4 kV
Rated voltage (II / 2)	630 V
Rated impulse voltage (II / 2)	4 kV

Rated current	16 A
---------------	------

### Approvals per UL 1059

Rated voltage UL (Use Group B)	300 V
Rated current UL (Use Group B)	15 A
Rated voltage UL (Use Group D)	300 V
Rated current UL (Use Group D)	10 A

### Approvals per UL 1977

Rated voltage per UL 1977 (factory wiring only)	600 V
Rated current per UL 1977 (factory wiring only)	15 A

### Approvals per CSA

Rated voltage CSA (Use Group B)	300 V
Rated current CSA (Use Group B)	15 A
Rated voltage CSA (Use Group D)	300 V
Rated current CSA (Use Group D)	10 A

### Connection data

Connection technology	CAGE CLAMP®
Actuation type	Operating tool
Solid conductor	0.08 ... 2.5 mm <sup>2</sup> / 28 ... 12 AWG
Fine-stranded conductor	0.08 ... 2.5 mm <sup>2</sup> / 28 ... 12 AWG
Fine-stranded conductor with ferrule with plastic collar	0.25 ... 1.5 mm <sup>2</sup>
Fine-stranded conductor with ferrule without plastic collar	0.25 ... 2.5 mm <sup>2</sup>
Strip length	8 ... 9 mm / 0.31 ... 0.35 inch
No. of poles	15
Total number of connection points	15
Total number of potentials	15
Number of connection types	1
Number of levels	1
Conductor entry direction to mating direction	0°

### Geometrical Data

Pin spacing	5 mm / 0.197 inch
Width	91.6 mm / 3.606 inch
Height	14.3 mm / 0.563 inch
Depth	29.6 mm / 1.165 inch

## Plug connection

Contact type (pluggable connector)	Female connector/socket
Connector connection type	for conductors
Mismating protection	No
Locking of plug-in connection	locking lever

## Material Data

Color	gray
Material group	I
Insulating material	Polyamide 66 (PA 66)
Flammability class per UL94	V0
Clamping spring material	Chrome nickel spring steel (CrNi)
Contact material	Copper alloy
Contact plating	tin-plated
Fire load	0.413 MJ
Weight	27.791 g

## Environmental Requirements

Limit temperature range	-60 ... +85 °C
-------------------------	----------------

## Commercial data

Product Group	3 (Multi Conn. System)
Country of origin	DE
GTIN	4044918342063
Customs Tariff No.	85366990990

## Approvals / Certificates

### Country specific Approvals

Logo	Approval	Additional Approval Text	Certificate name
	<b>CB</b> DEKRA Certification B.V.	IEC 61984	NL-39756
	<b>CSA</b> DEKRA Certification B.V.	C22.2	1466354

### Ship Approvals



Logo	Approval	Additional Approval Text	Certificate name
	<b>ABS</b> American Bureau of Shipping	-	14- HG1241537-

**DNV GL**

Det Norske Veritas, Germanischer Lloyd







TAE000016Z



















## UL-Approvals

















Logo	Approval	Additional Approval Text	Certificate name
	UR UL International Germany GmbH	UL 1977	E45171
	UR UL International Germany GmbH	UL 1977	E45171

## Compatible products





## ferrule

	<b>Item no.: 216-101</b> Ferrule; Sleeve for 0.5 mm <sup>2</sup> / AWG 22; uninsulated; electro-tin plated	216-101
	<b>Item no.: 216-102</b> Ferrule; Sleeve for 0.75 mm <sup>2</sup> / AWG 20; uninsulated; electro-tin plated	216-102
	<b>Item no.: 216-103</b> Ferrule; Sleeve for 1 mm <sup>2</sup> / AWG 18; uninsulated; electro-tin plated	216-103
	<b>Item no.: 216-104</b> Ferrule; Sleeve for 1.5 mm <sup>2</sup> / AWG 16; uninsulated; electro-tin plated	216-104
	<b>Item no.: 216-106</b> Ferrule; Sleeve for 2.5 mm <sup>2</sup> / AWG 14; uninsulated; electro-tin plated	216-106
	<b>Item no.: 216-121</b> Ferrule; Sleeve for 0.5 mm <sup>2</sup> / AWG 22; uninsulated; electro-tin plated	216-121
	<b>Item no.: 216-122</b> Ferrule; Sleeve for 0.75 mm <sup>2</sup> / AWG 20; uninsulated; electro-tin plated	216-122





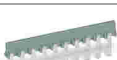

	<b>Item no.: 216-123</b> Ferrule; Sleeve for 1 mm <sup>2</sup> / AWG 18; uninsulated; electro-tin plated	216-123
	<b>Item no.: 216-124</b> Ferrule; Sleeve for 1.5 mm <sup>2</sup> / AWG 16; uninsulated; electro-tin plated	216-124
	<b>Item no.: 216-131</b> Ferrule; Sleeve for 0.25 mm <sup>2</sup> / AWG 24; uninsulated; electro-tin plated	216-131
	<b>Item no.: 216-132</b> Ferrule; Sleeve for 0.34 mm <sup>2</sup> / AWG 24; uninsulated; electro-tin plated	216-132
	<b>Item no.: 216-141</b> Ferrule; Sleeve for 0.5 mm <sup>2</sup> / 20 AWG; uninsulated; electro-tin plated; electrolytic copper; gastight crimped; acc. to DIN 46228, Part 1/08.92	216-141
	<b>Item no.: 216-142</b> Ferrule; Sleeve for 0.75 mm <sup>2</sup> / 18 AWG; uninsulated; electro-tin plated; electrolytic copper; gastight crimped; acc. to DIN 46228, Part 1/08.92	216-142
	<b>Item no.: 216-143</b> Ferrule; Sleeve for 1 mm <sup>2</sup> / AWG 18; uninsulated; electro-tin plated; electrolytic copper; gastight crimped; acc. to DIN 46228, Part 1/08.92	216-143
	<b>Item no.: 216-144</b> Ferrule; Sleeve for 1.5 mm <sup>2</sup> / AWG 16; uninsulated; electro-tin plated; electrolytic copper; gastight crimped; acc. to DIN 46228, Part 1/08.92	216-144
	<b>Item no.: 216-151</b> Ferrule; Sleeve for 0.25 mm <sup>2</sup> / AWG 24; uninsulated; electro-tin plated	216-151
	<b>Item no.: 216-152</b> Ferrule; Sleeve for 0.34 mm <sup>2</sup> / AWG 24; uninsulated; electro-tin plated	216-152
	<b>Item no.: 216-201</b> Ferrule; Sleeve for 0.5 mm <sup>2</sup> / 20 AWG; insulated; electro-tin plated	216-201
	<b>Item no.: 216-202</b> Ferrule; Sleeve for 0.75 mm <sup>2</sup> / 18 AWG; insulated; electro-tin plated	216-202
	<b>Item no.: 216-203</b> Ferrule; Sleeve for 1 mm <sup>2</sup> / AWG 18; insulated; electro-tin plated	216-203
	<b>Item no.: 216-204</b> Ferrule; Sleeve for 1.5 mm <sup>2</sup> / AWG 16; insulated; electro-tin plated	216-204
	<b>Item no.: 216-221</b> Ferrule; Sleeve for 0.5 mm <sup>2</sup> / 20 AWG; insulated; electro-tin plated	216-221
	<b>Item no.: 216-222</b> Ferrule; Sleeve for 0.75 mm <sup>2</sup> / 18 AWG; insulated; electro-tin plated	216-222
	<b>Item no.: 216-223</b> Ferrule; Sleeve for 1 mm <sup>2</sup> / AWG 18; insulated; electro-tin plated	216-223
	<b>Item no.: 216-224</b> Ferrule; Sleeve for 1.5 mm <sup>2</sup> / AWG 16; insulated; electro-tin plated	216-224
	<b>Item no.: 216-241</b> Ferrule; Sleeve for 0.5 mm <sup>2</sup> / 20 AWG; insulated; electro-tin plated; electrolytic copper; gastight crimped; acc. to DIN 46228, Part 4/09.90	216-241
	<b>Item no.: 216-242</b>	

	Ferrule; Sleeve for 0.75 mm <sup>2</sup> / 18 AWG; insulated; electro-tin plated; electrolytic copper; gastight crimped; acc. to DIN 46228, Part 4/09.90	216-242
	<b>Item no.: 216-243</b>	
	Ferrule; Sleeve for 1 mm <sup>2</sup> / AWG 18; insulated; electro-tin plated; electrolytic copper; gastight crimped; acc. to DIN 46228, Part 4/09.90	216-243
	<b>Item no.: 216-244</b>	
	Ferrule; Sleeve for 1.5 mm <sup>2</sup> / AWG 16; insulated; electro-tin plated; electrolytic copper; gastight crimped; acc. to DIN 46228, Part 4/09.90	216-244
	<b>Item no.: 216-262</b>	
	Ferrule; Sleeve for 0.75 mm <sup>2</sup> / 18 AWG; insulated; electro-tin plated; electrolytic copper; gastight crimped; acc. to DIN 46228, Part 4/09.90	216-262
	<b>Item no.: 216-263</b>	
	Ferrule; Sleeve for 1 mm <sup>2</sup> / AWG 18; insulated; electro-tin plated; electrolytic copper; gastight crimped; acc. to DIN 46228, Part 4/09.90	216-263
	<b>Item no.: 216-264</b>	
	Ferrule; Sleeve for 1.5 mm <sup>2</sup> / AWG 16; insulated; electro-tin plated; electrolytic copper; gastight crimped; acc. to DIN 46228, Part 4/09.90	216-264
	<b>Item no.: 216-284</b>	
	Ferrule; Sleeve for 1.5 mm <sup>2</sup> / AWG 16; insulated; electro-tin plated; electrolytic copper; gastight crimped; acc. to DIN 46228, Part 4/09.90	216-284
	<b>Item no.: 216-301</b>	
	Ferrule; Sleeve for 0.25 mm <sup>2</sup> / AWG 24; insulated; electro-tin plated	216-301
	<b>Item no.: 216-302</b>	
	Ferrule; Sleeve for 0.34 mm <sup>2</sup> / 22 AWG; insulated; electro-tin plated	216-302
	<b>Item no.: 216-321</b>	
	Ferrule; Sleeve for 0.25 mm <sup>2</sup> / AWG 24; insulated; electro-tin plated	216-321
	<b>Item no.: 216-322</b>	
	Ferrule; Sleeve for 0.34 mm <sup>2</sup> / 22 AWG; insulated; electro-tin plated	216-322
<b>check</b>		
	<b>Item no.: 210-136</b> Test plug; 2 mm Ø; with 500 mm cable	210-136
	<b>Item no.: 210-137</b> Test plug; 2.3 mm Ø; with 500 mm cable	210-137
	<b>Item no.: 231-661</b> Test plugs for female connectors; for 5 mm and 5.08 mm pin spacing	231-661
<b>Insulation stop</b>		
	<b>Item no.: 231-670</b> Insulation stop; 0.08-0.2 mm <sup>2</sup> / 0.2 mm <sup>2</sup> "s"	231-670
	<b>Item no.: 231-671</b> Insulation stop; 0.25 - 0.5 mm <sup>2</sup>	231-671
	<b>Item no.: 231-672</b> Insulation stop; 0.75 - 1 mm <sup>2</sup>	231-672
<b>General accessories</b>		
	<b>Item no.: 231-668</b> Lockout caps; for covering unused clamping units	231-668





## Jumper









	<b>Item no.: 231-902</b> Comb-style jumper bar; for 5 mm and 5.08 mm pin spacing; reduces conductor size to 1.5 mm	231-902
	<b>Item no.: 231-903</b> Comb-style jumper bar; 3-way; suitable for 231 Series female connectors; with 5 mm pin spacing; insulated	231-903
	<b>Item no.: 231-905</b> Comb-style jumper bar; 5-way; suitable for 231 Series female connectors; with 5 mm pin spacing; insulated	231-905
	<b>Item no.: 231-907</b> Comb-style jumper bar; 7-way; suitable for 231 Series female connectors; with 5 mm pin spacing; insulated	231-907
	<b>Item no.: 231-910</b> Comb-style jumper bar; 10-way; suitable for 231 Series female connectors; with 5 mm pin spacing; insulated	231-910

## Marking accessories

	<b>Item no.: 210-331/500-103</b> Marking strips; as a DIN A4 sheet; MARKED; 1-12 (300x); Height of marker strip: 2.3 mm/0.091 in; Strip length 182 mm; Horizontal marking; Self-adhesive	 210-331
	<b>Item no.: 210-331/500-104</b> Marking strips; as a DIN A4 sheet; MARKED; 13-24 (300x); Height of marker strip: 2.3 mm/0.091 in; Strip length 182 mm; Horizontal marking; Self-adhesive	 210-331
	<b>Item no.: 210-332/500-202</b> Marking strips; as a DIN A4 sheet; MARKED; 1-16 (160x); Height of marker strip: 3 mm; Strip length 182 mm; Horizontal marking; Self-adhesive	 210-332
	<b>Item no.: 210-332/500-204</b> Marking strips; as a DIN A4 sheet; MARKED; 17-32 (160x); Height of marker strip: 3 mm; Strip length 182 mm; Horizontal marking; Self-adhesive	 210-332
	<b>Item no.: 210-332/500-205</b> Marking strips; as a DIN A4 sheet; MARKED; 1-32 (80x); Height of marker strip: 3 mm; Strip length 182 mm; Horizontal marking; Self-adhesive	 210-332
	<b>Item no.: 210-332/500-206</b> Marking strips; as a DIN A4 sheet; MARKED; 33-48 (160x); Height of marker strip: 3 mm; Strip length 182 mm; Horizontal marking; Self-adhesive	 210-332

## tools

	<b>Item no.: 209-130</b> Operating tool; suitable for 264, 280 and 281 Series; 1-way; of insulating material	209-130
	<b>Item no.: 209-132</b> Operating tool; for connecting comb-style jumper bar; 2-way; of insulating material	209-132
	<b>Item no.: 231-131</b> Push-button; for female and male connectors; loose	231-131
	<b>Item no.: 231-159</b> Operating tool; for male and female connectors with CAGE CLAMP®; of Series 231, 232, 721, 722, 723, 731, 732	231-159
	<b>Item no.: 231-231</b> Combination operating tool; for male and female connectors with CAGE CLAMP®	231-231

	<b>Item no.: 231-291</b> Operating tool; for male and female connectors with CAGE CLAMP®; loose	231-291
	<b>Item no.: 280-432</b> Operating tool; of insulating material; 2-way	280-432
	<b>Item no.: 280-433</b> Operating tool; of insulating material; 3-way	280-433
	<b>Item no.: 280-434</b> Operating tool; of insulating material; 4-way	280-434
	<b>Item no.: 280-435</b> Operating tool; of insulating material; 5-way	280-435
	<b>Item no.: 280-436</b> Operating tool; of insulating material; 6-way	280-436
	<b>Item no.: 280-437</b> Operating tool; of insulating material; 7-way	280-437
	<b>Item no.: 280-438</b> Operating tool; of insulating material; 8-way	280-438
	<b>Item no.: 280-440</b> Operating tool; of insulating material; 10-way	280-440

Downloads

CAD/CAE - Smart Data

CAD data

	URL	Download
3D Download 231-115/037-000		

Subject to changes.